

TOP
scale 1:10

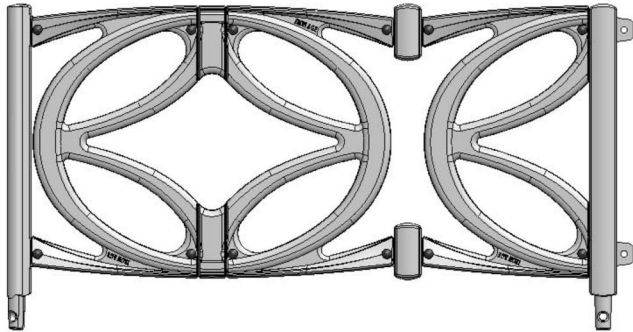

FRONT
scale 1:10



R SIDE
scale 1:10

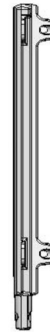

REAR
scale 1:10

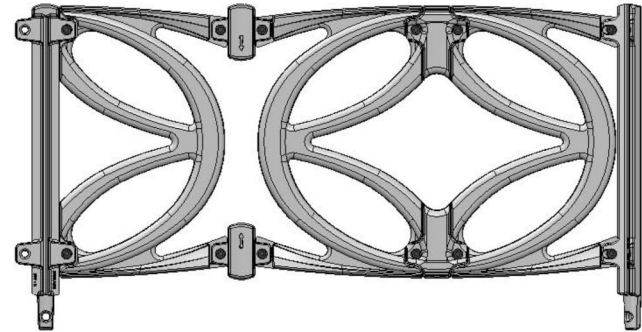

TOP
scale 1:10

FRONT EXLODED
scale 1:10

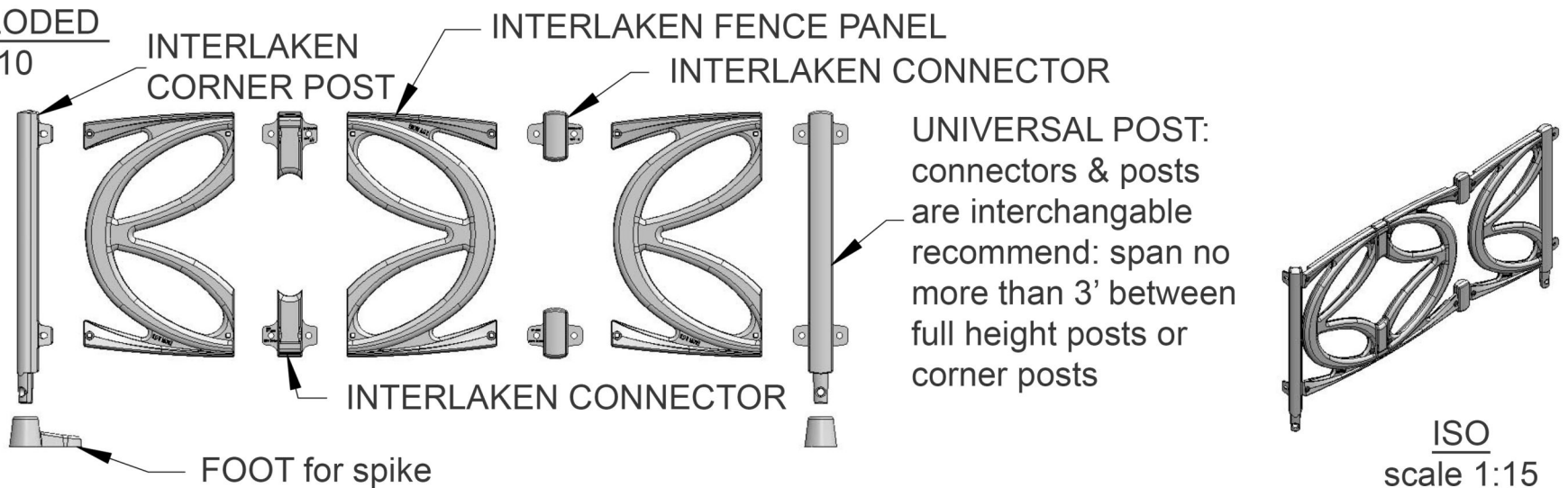

Pattern : Interlaken

Material : Cast Ductile Iron

Interlaken 915 mm Planting Fence

Interlaken Planter Fence

Finish : Natural or powder coat paint

Thickness : N/A

Drawing no : INT-PF-915

Product no : CI-66-915PF

1. Due to casting inconsistencies all dimensions are nominal

Dimensions : 914,4 x 508

Units : mm



Unit 5 Cotswold Business Park
Millfield Lane
Beds LU1 4AJ

Load Class : N/A

Flow rate : N/A

info@lateraldesignstudio.co.uk

0208 450 2244

INTERLAKEN 2'x 2'
PLANTER FENCE
scale 1:10

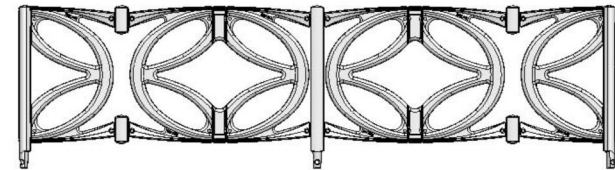
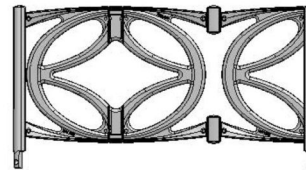
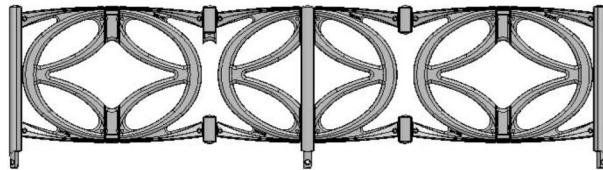
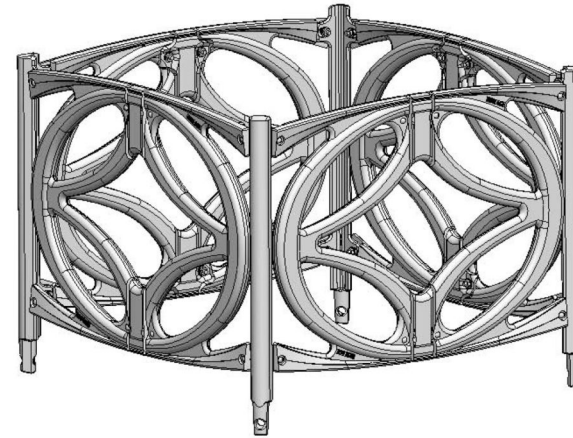
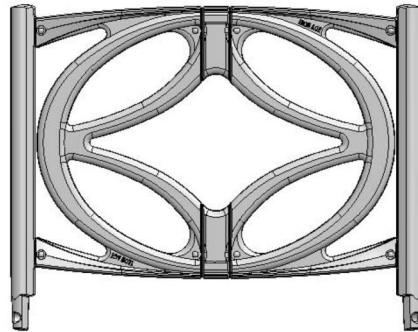

INTERLAKEN 3'x 6' PLANTER FENCE scale 1:20

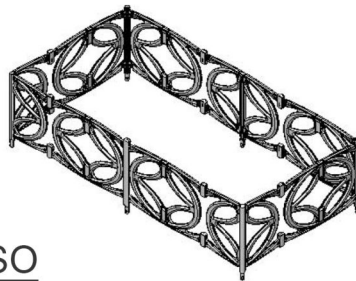
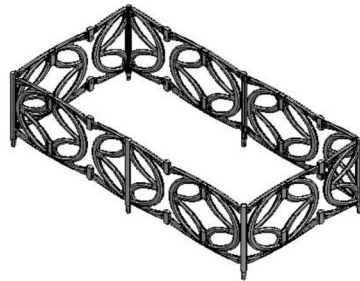

ISO
scale 1:36

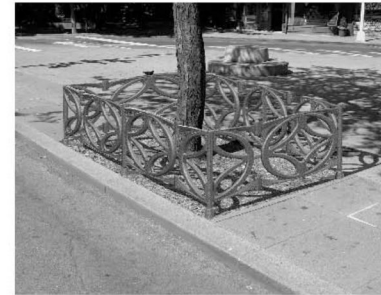

TOP VIEWS

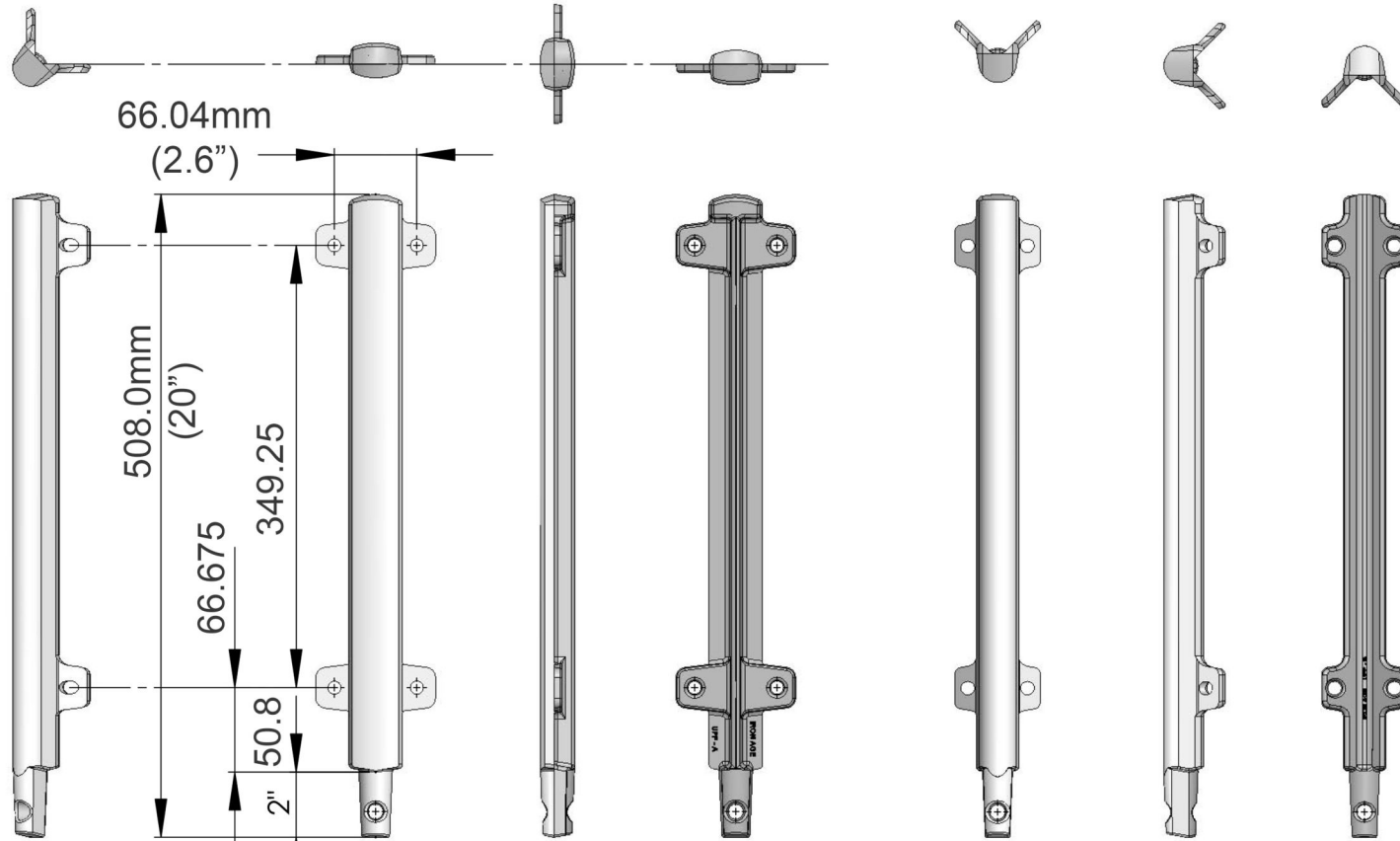

shown NORMAL
to fence line
CORNER POST

FRONT SIDE REAR
shown NORMAL to fence & Parting line
UNIVERSAL POST

FRONT SIDE REAR
shown NORMAL to Parting line
CORNER POST



Pattern : Interlaken

Material : Cast Ductile Iron

Interlaken 915 mm Planting Fence

Interlaken Planter Fence

Finish : Natural or powder coat paint

Thickness : N/A

Drawing no : INT-PF-915

Product no : CI-66-915PF

Dimensions : 914,4 x 508

Units : mm



Unit 5 Cotswold Business Park
Millfield Lane
Beds LU1 4AJ

Load Class : N/A

Flow rate : N/A

info@lateraldesignstudio.co.uk

0208 450 2244

TOP VIEWS



INTERLAKEN CONNECTOR
FRONT

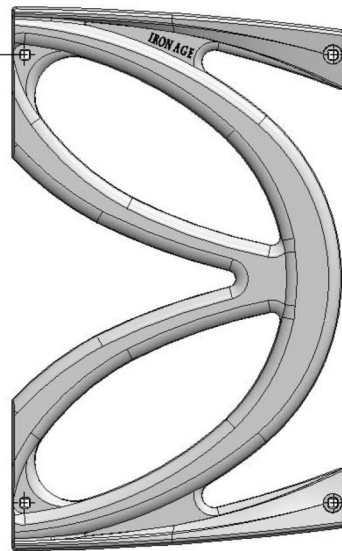
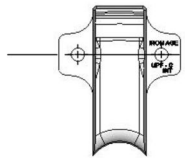

FRONT

INTERLAKEN PANEL

INTERLAKEN CONNECTOR
REAR SIDE

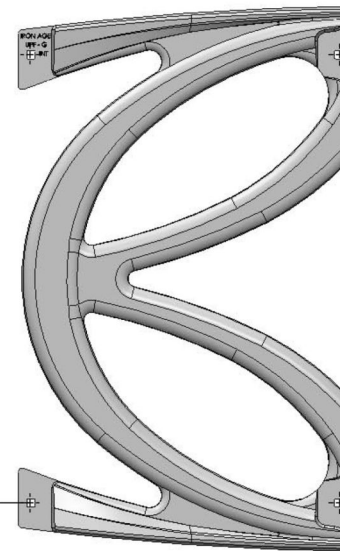
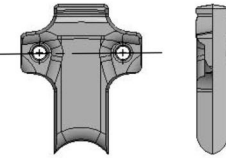

REAR

INTERLAKEN PANEL

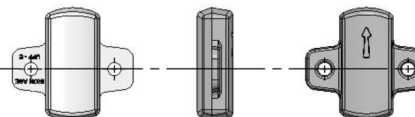

FRONT SIDE REAR

UNIVERSAL CONNECTOR



Pattern : Interlaken

Material : Cast Ductile Iron

Interlaken 915 mm Planting Fence

Interlaken Planter Fence

Finish : Natural or powder coat paint

Thickness : N/A

Drawing no : INT-PF-915

Product no : CI-66-915PF

1. Due to casting inconsistencies all dimensions are nominal

Dimensions : 914,4 x 508

Units : mm



Unit 5 Cotswold Business Park
Millfield Lane
Beds LU1 4AJ

Load Class : N/A

Flow rate : N/A

info@lateraldesignstudio.co.uk

0208 450 2244

EXPLODED
ISOMETRIC

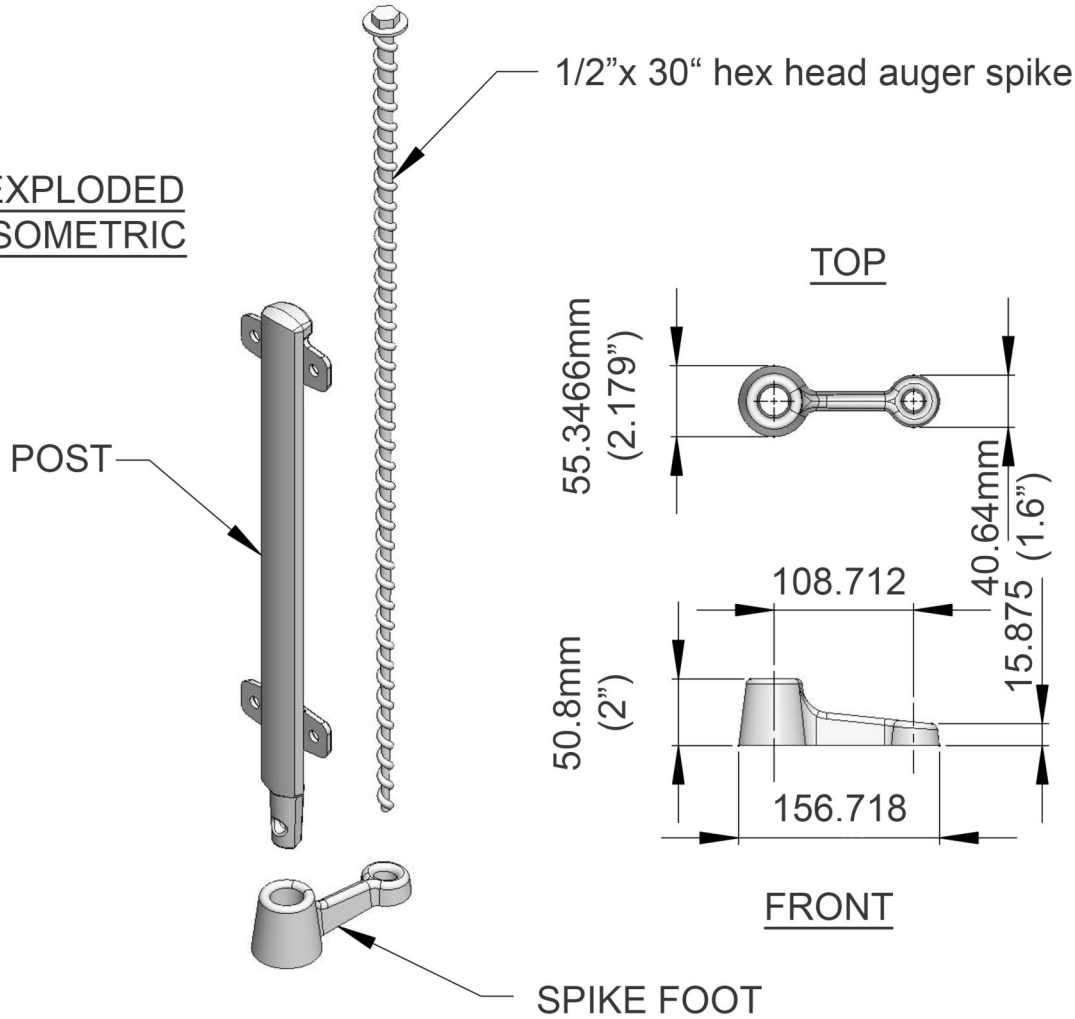

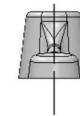
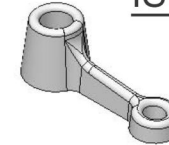

ISOMETRIC



FRONT

END

 <p>IRON AGE DESIGNS www.ironagegrates.co.uk</p>	Pattern : Interlaken	Material : Cast Ductile Iron	Interlaken 915 mm Planting Fence Interlaken Planter Fence	
	Finish : Natural or powder coat paint	Thickness : N/A	Drawing no : INT-PF-915	Product no : CI-66-915PF
	Dimensions : 914,4 x 508	Units : mm	 LATERAL DESIGN STUDIO www.lateraldesignstudio.co.uk	
1. Due to casting inconsistencies all dimensions are nominal	Load Class : N/A	Flow rate : N/A	 ACID ANTI COPYING IN DESIGN	Unit 5 Cotswold Business Park Millfield Lane Beds LU1 4AJ info@lateraldesignstudio.co.uk
Copyright 2011-2016 Lateral Design Studio Limited. This drawing and subject matter disclosed therein, embody proprietary information which is the confidential property of Lateral Design Studio Ltd, none of which shall be copied, reproduced, disclosed to others, published or used, in whole or in part, without the express advanced written permission of a duly authorised agent of the company. This drawing is subject to recall by Lateral Design Studio Ltd.			0208 450 2244	

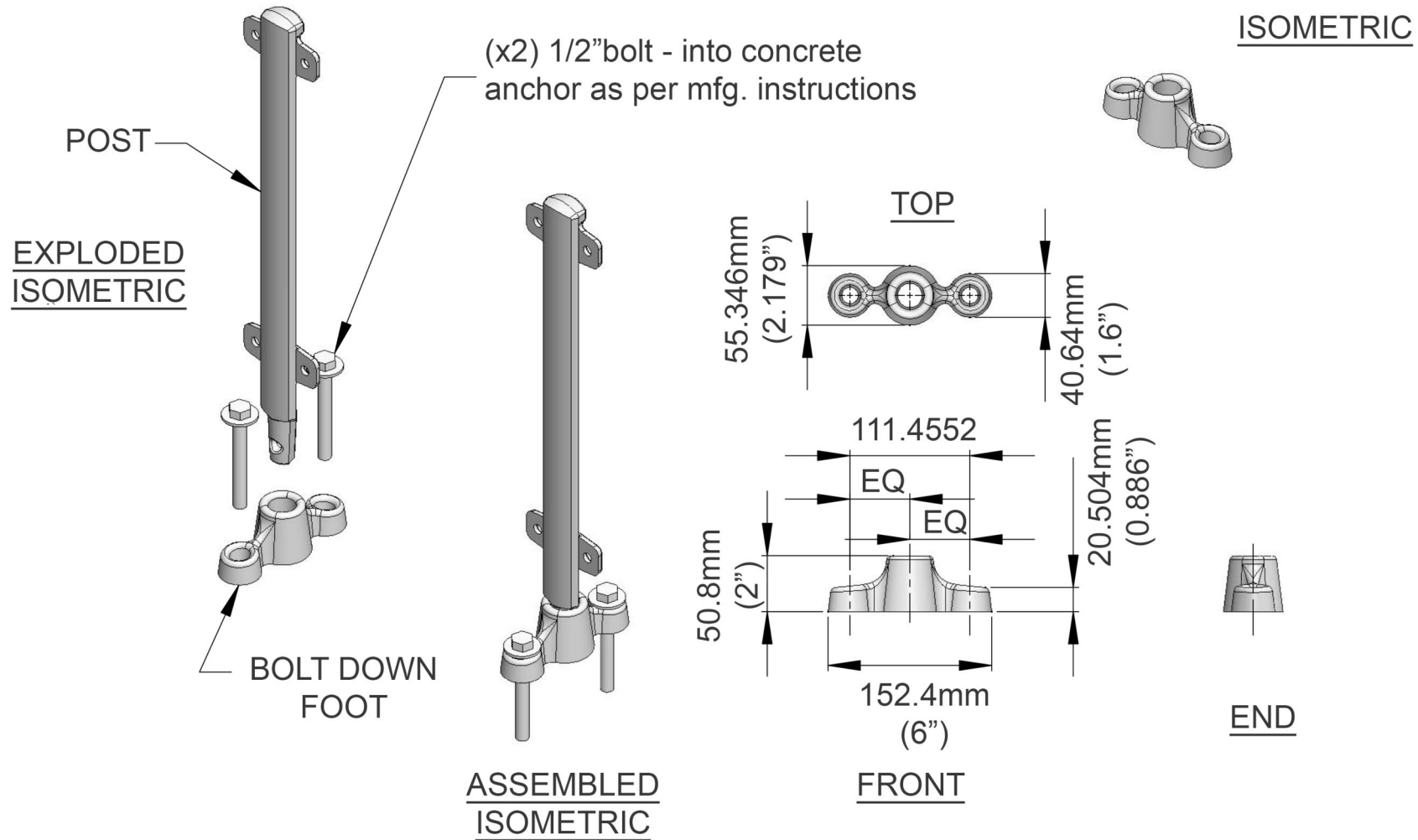

Pattern : Interlaken

Material : Cast Ductile Iron

Interlaken 915 mm Planting Fence

Interlaken Planter Fence

Finish : Natural or powder coat paint

Thickness : N/A

Drawing no : INT-PF-915

Product no : CI-66-915PF

Dimensions : 914,4 x 508

Units : mm



Unit 5 Cotswold Business Park
Millfield Lane
Beds LU1 4AJ

Load Class : N/A

Flow rate : N/A

info@lateraldesignstudio.co.uk

0208 450 2244



UNIVERSAL CORNER POST - mounting options :

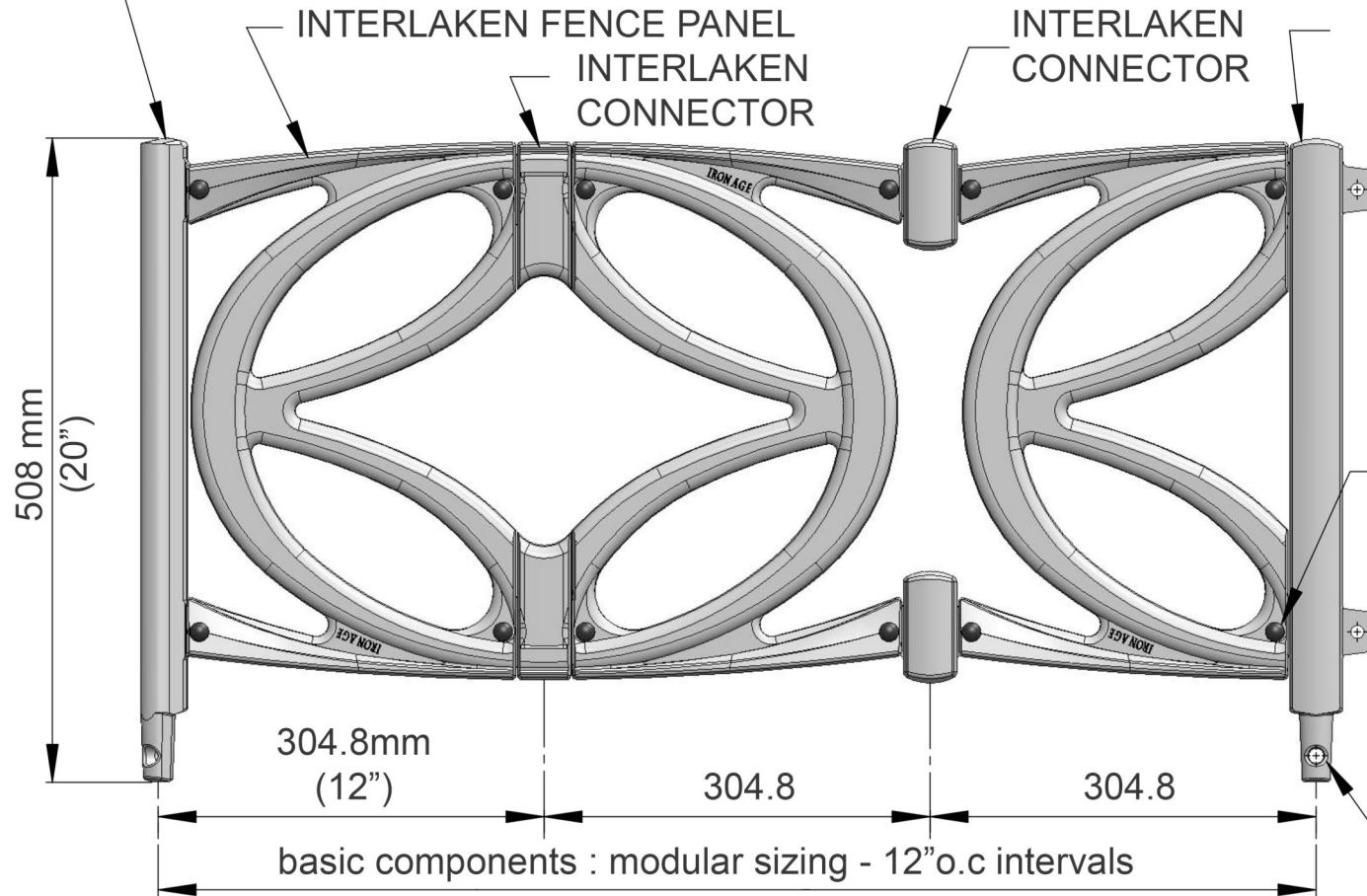

- 1) tapered base fits snugly into standard 1" pipe (recommend: bed in silicone) optional set screw
- 2) feet available; for spike or bolt down
- 3) hole can accommodate #3 rebar to directly cast in concrete

UNIVERSAL POST:
- same mounting ops,
connectors & posts
are interchangeable



panel fasteners :
0.25-20UNC x 0.75"
s/s button head
security screws,
jam nuts &
small diameter
washers

Hole for #3 rebar

 <p>IRON AGE DESIGNS www.ironagegrates.co.uk</p>	Pattern : Interlaken Finish : Natural or powder coat paint	Material : Cast Ductile Iron Thickness : N/A	Interlaken 915 mm Planting Fence Interlaken Planter Fence	
	Dimensions : 914,4 x 508 Load Class : N/A	Units : mm Flow rate : N/A	Drawing no : INT-PF-915  www.lateraldesignstudio.co.uk	Product no : CI-66-915PF Unit 5 Cotswold Business Park Millfield Lane Beds LU1 4AJ
	1. Due to casting inconsistencies all dimensions are nominal		info@lateraldesignstudio.co.uk	0208 450 2244